

Article number: 0101013
 Description: Retaining ring A 4 DIN 471
 Spring steel
 Note: Fitted with ZGA pilers

Measures

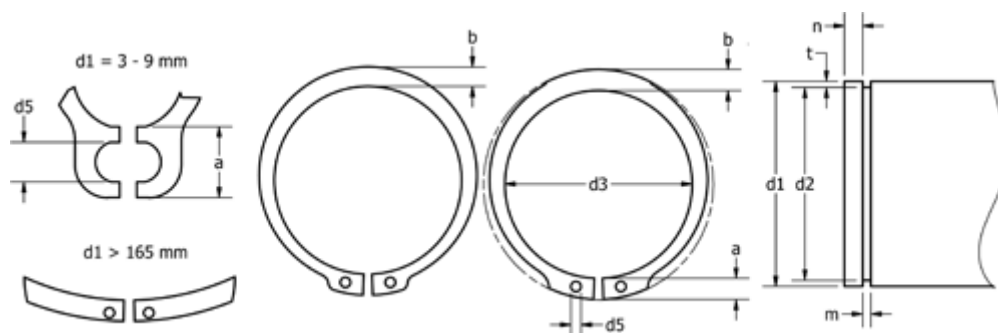

a max	= 2.2	FN kN	= 0.2	s	= 0.40
AN mm ²	= 1.2	FRg kN	= 0.30	t	= 0.10
b	= 0.9	FR kN	= 0.50	tol	= -0.04
d1	= 4	g	= 0.5	tol	= -0.05
d2	= 3.8	K kN-mm	= 1.93	tol	= +0,04-0,15
d3	= 3.7	m min	= 0.50	Tong	= ZGA-0
d5 min	= 1.0	n abl x 1000	= 211.0	Weight kg/1000	= 0.022
Description	= A4	Nominal drive	= 0.3		